

# SERVICE MANUAL

**NAD**

**C 160**

**PRE-  
AMPLIFIER**

**C160**

**PRE-  
AMPLIFIER**

# TABLE OF CONTENTS

<u>DESCRIPTION</u>	<u>PAGE</u>
SPECIFICATIONS.....	3
REAR PANEL/FRONT PANEL VIEW.....	4
WIRING DIAGRAM.....	5
PCB LAYOUT.....	6-7
SCHEMATIC DIAGRAM.....	8
ELECTRICAL PARTS LIST.....	9-13
EXPLODED VIEW PARTS LIST.....	14
EXPLODED VIEW .....	15
PACKING DIAGRAM.....	16

## SERVICE SAFETY PRECAUTIONS

### 1. Replacing the fuses

CAUTION: FOR CONTINUED PROTECTION AGAINST THE RISK OF FIRE, REPLACE ONLY WITH DESIGNATED TYPE OF FUSE.

Reference No.	Part Number	Description
F702-F707	20-00050-25	T500mA 250V Time-lag

### 2. Safety check out

(Only U.S.A. Model)

Before returning the product to the customer, make leakage current or resistance measurements to determine that exposed parts are acceptably insulated from the supply circuit.

Parts marked with the symbol  are critical with regard to the risk of fire and electric shock. Replace Only with parts recommended by the manufacturer.

# REAR PANEL/FRONT PANEL VIEW

## REAR PANEL

**WARNING: TO PREVENT FIRE OR ELECTRIC SHOCK, DO NOT EXPOSE THIS APPLIANCE TO RAIN OR MOISURE.**

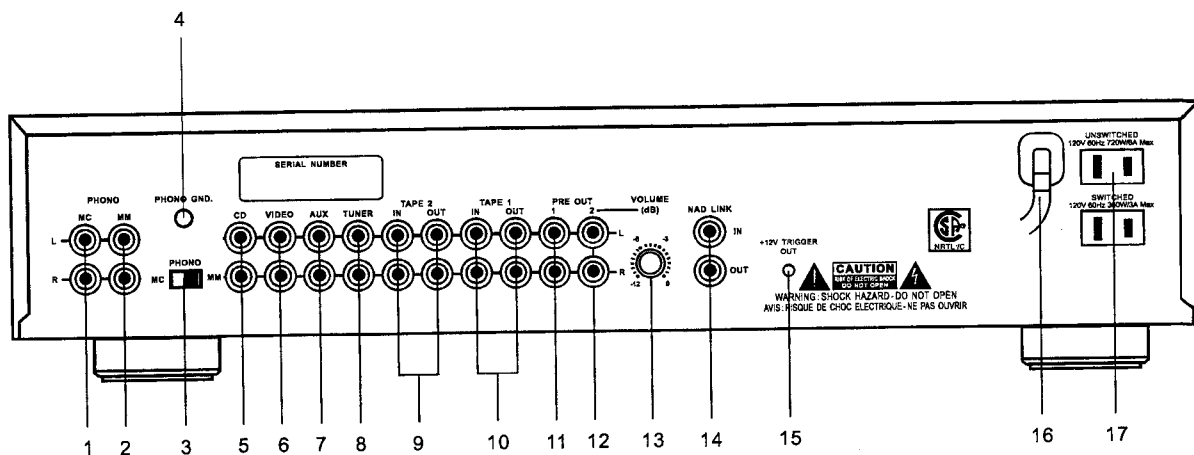

- |  |   |
|--|---|
| <ol style="list-style-type: none"> <li>1. MC Input</li> <li>2. MM Input</li> <li>3. MM-MC Switch</li> <li>4. Phono Ground Connector</li> <li>5. CD Input</li> <li>6. Video Input</li> <li>7. Aux Input</li> <li>8. Tuner Input</li> <li>9. Tape 2 In, Out</li> </ol> | <ol style="list-style-type: none"> <li>10. Tape 1 In, Out</li> <li>11. PRE Out 1</li> <li>12. PRE Out 2</li> <li>13. Pre Out 2 Volume</li> <li>14. NAD Link In, Out</li> <li>15. 12V Trigger Out</li> <li>16. AC Line Cord</li> <li>17. Switched and Unswitched Power Outlets(AH Version Only)</li> </ol> |
|--|---|

<p>The lightning flash with arrowhead, within an equilateral triangle is intended to alert the user of the presence of un-insulated "dangerous voltage" within the product's enclosure; that may be of sufficient magnitude to constitute a risk of electric shock to persons.</p>	<p>The exclamation point within an equilateral triangle is intended to alert the user of the presence of important operating and maintenance (servicing) instructions in the literature accompanying the appliance.</p>
--	---

## FRONT PANEL

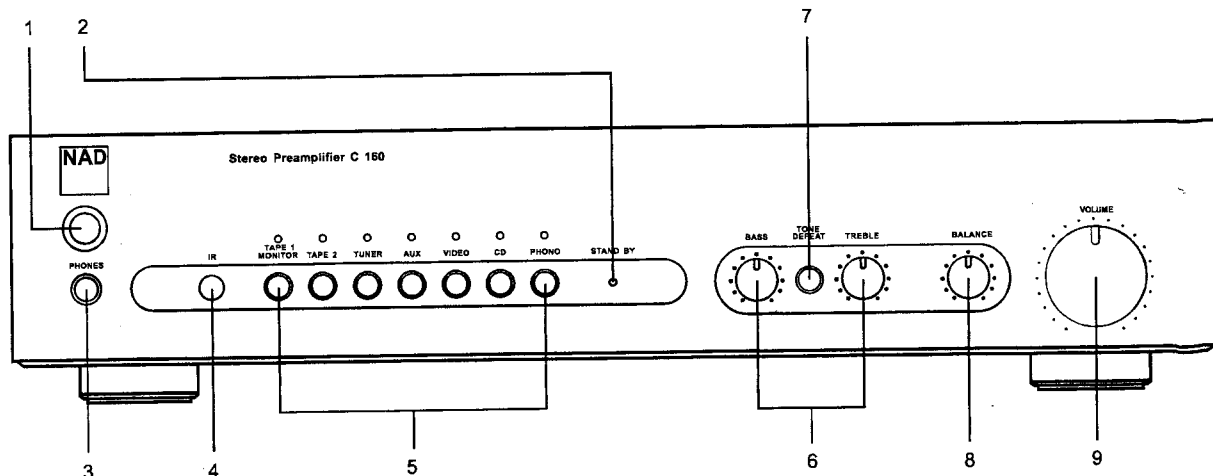

- |  |  |
|--|--|
| <ol style="list-style-type: none"> <li>1. Power On/Off</li> <li>2. Stand-by Indicator</li> <li>3. Headphone Socket</li> <li>4. Infra-red Receiver</li> <li>5. Input Selectors</li> </ol> | <ol style="list-style-type: none"> <li>6. Bass &amp; Treble Controls</li> <li>7. Tone Defeat</li> <li>8. Balance</li> <li>9. Volume</li> </ol> |
|--|--|

# SPECIFICATIONS

Measured in accordance with EIA Standard RS-490(IHF A-202).

## PHONO INPUTS

Input impedance (R and C)	MM.....	47kohm +470pF
	MC.....	100ohm + 1nF
Input sensitivity	MM.....	2.10mV
	MC.....	115uV
Input overload at 20Hz/1kHz/20kHz	MM.....	20mV, 230mV, 2V
	MC.....	1.3mV, 12mV, 110mV
Signal/Noise ratio (A-weighted)	MM.....	80dB(1k Source)
		77dB (IHF Source)
	MC.....	81dB(10ohm Source)
		76dB(100ohm Source)
THD(20Hz-20kHz) and IM distortion (5Vrms at Tape out)	MM/MC.....	<0.03%
RIAA response accuracy	MM.....	±0.4dB
	MC.....	±0.4dB
Infrasonic Filter.....		12dB/Oct,-3dB@10Hz

## LINE LEVEL INPUTS (CD, Video, Tuner, Tape1, Tape2, Aux)

Input impedance (R and C).....		500kohm, 320pF
Input sensitivity ref. 0.5V.....		150mV
Signal/Noise ratio, A-weighted ref. 0.5V.....		>100dB
Frequency response, 20Hz-20kHz	Tone Defeat.....	±0.2dB
	Tone In.....	±0.3dB
Voltage gain(Max Volume).....		10.5dB
THD + SMPTE + IHF I.M.	at 1V in.....	<0.01%
	at 5V in/out.....	<0.03%
Maximum i/p level	20Hz/1k/20k.....	17V

## LINE LEVEL OUTPUTS

Output impedance	Pre out1.....	75ohm
	Pre out2(Variable).....	350ohm
	Tape.....	Source Z +1kohm
	Headphones.....	100ohm
Maximum output level	Pre out.....	15V(IHF Load)
	Tape.....	15V(IHF Load)
	Phones.....	10V(600ohm)
		190mV(8ohm)

## CONTROLS (Volume Setting @12:00 position)

Treble.....		±5dB@10kHz
Bass.....		±5dB@100Hz

## PHYSICAL SPECIFICATIONS

Dimensions in mm (Width × Height × Depth).....		435 × 95 × 310
Net Weight.....		4.6KG
Shipping Weight.....		6.0KG

# WIRING DIAGRAM

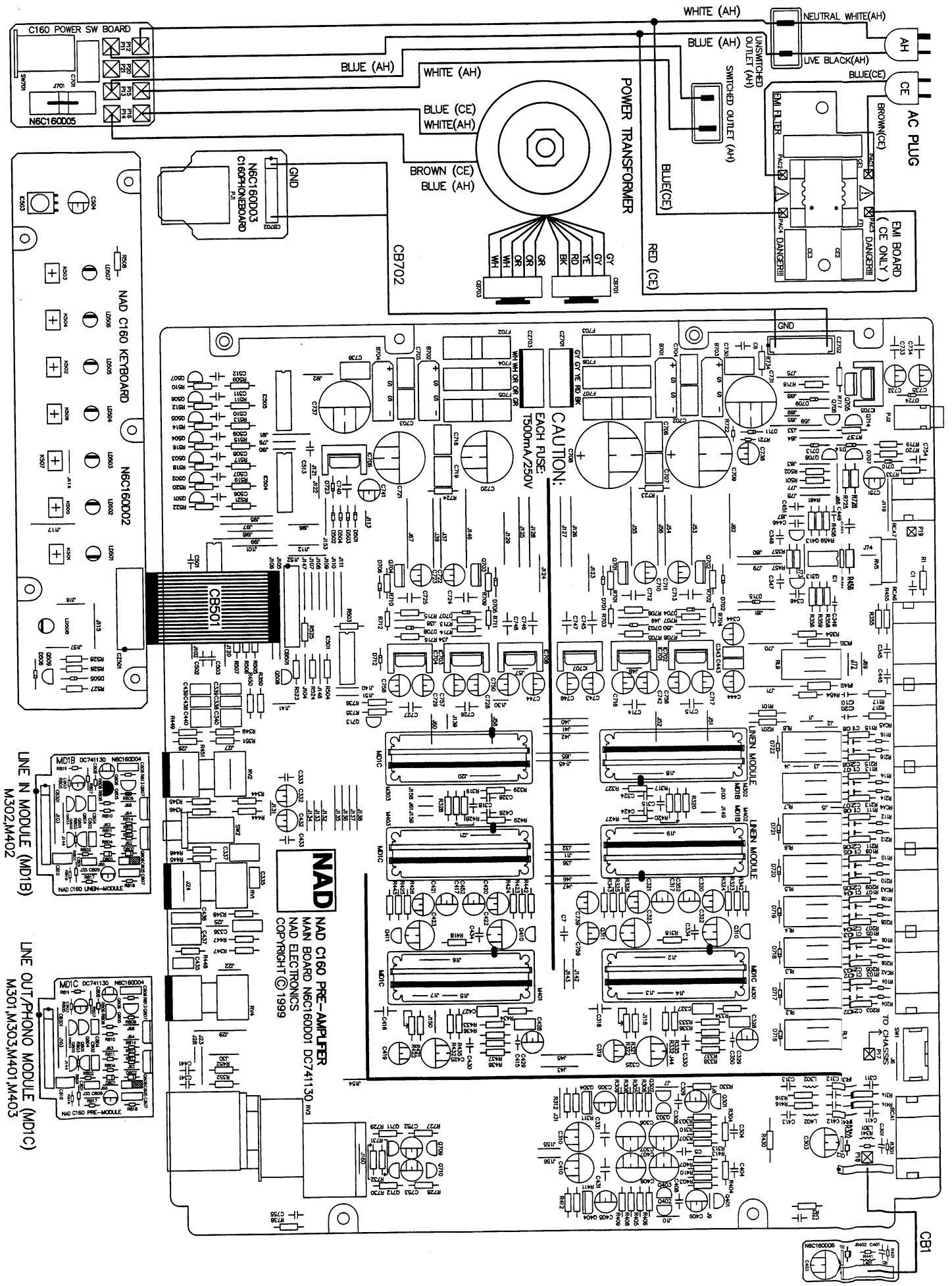

# PCB LAYOUT

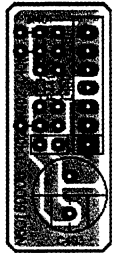
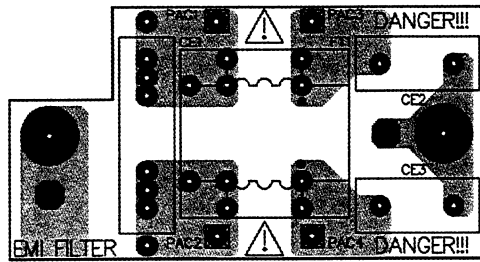
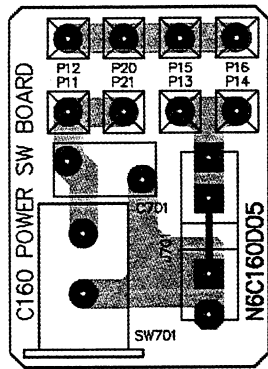
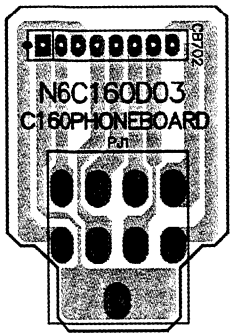

HEADPHONE BOARD POWER SWITCH BOARD

EMI FILTER BOARD

MC RCH BOARD

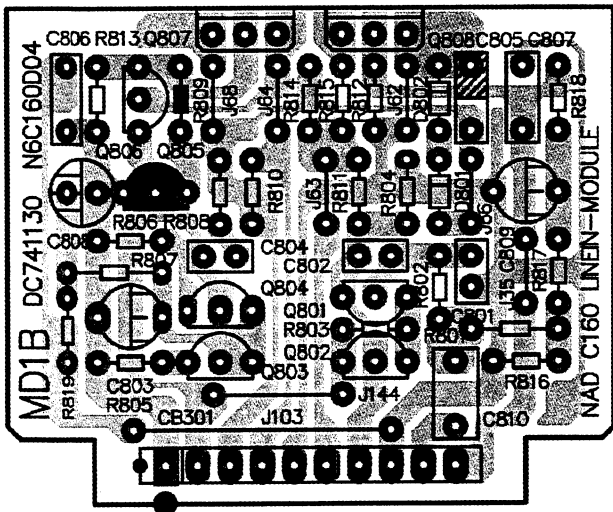

LINE IN MODULE BOARD

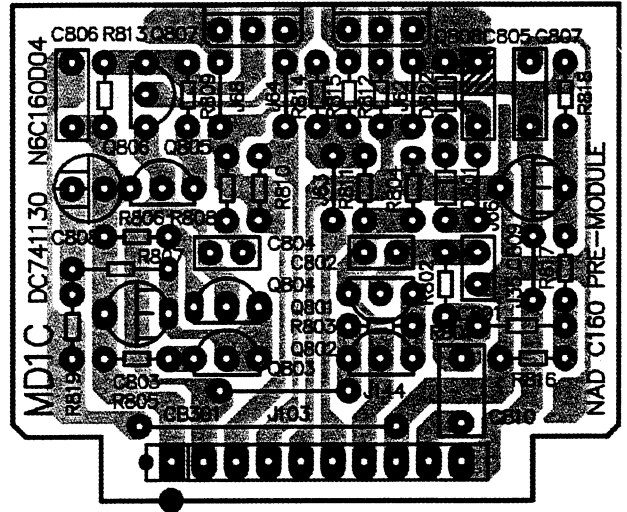

LINE OUT MODULE BOARD / PHONO MODULE BOARD

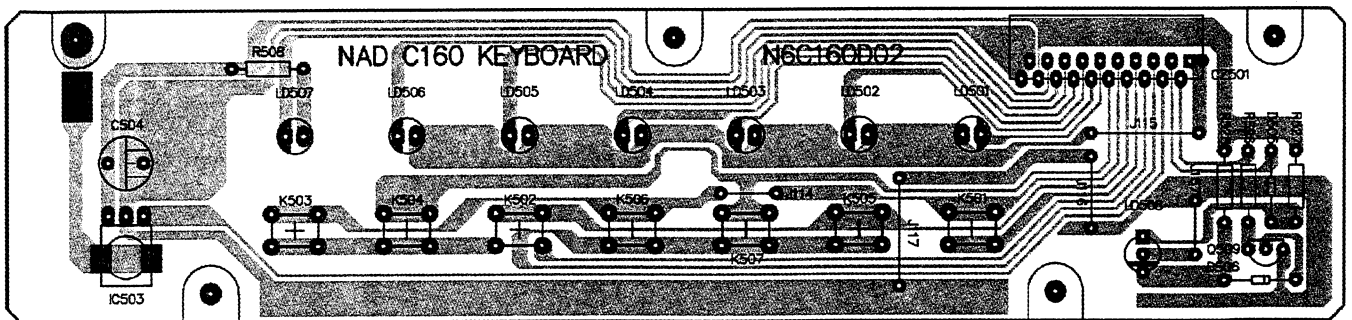

KEY CONTROL BOARD





# SCHEMATIC DIAGRAM

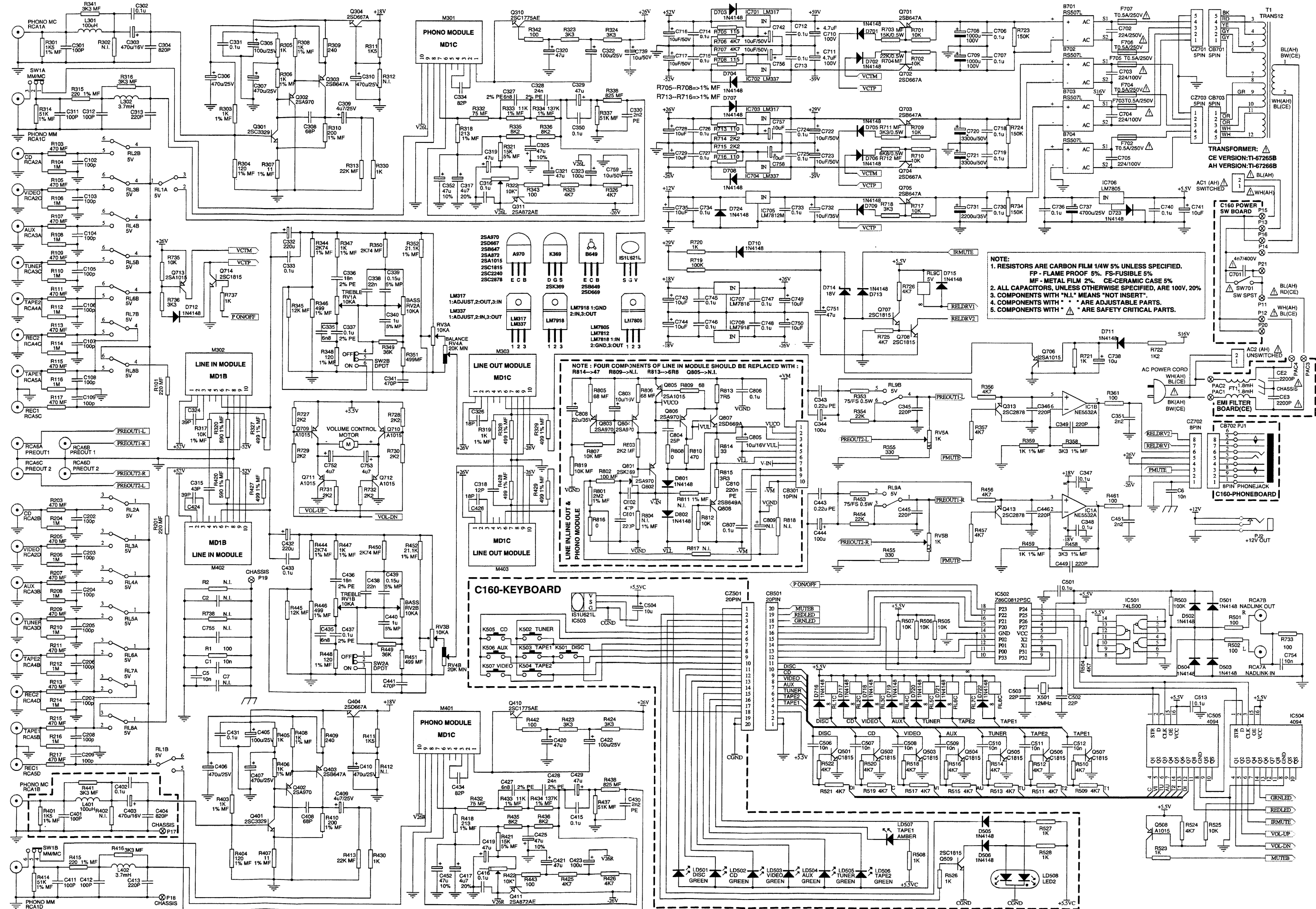



# ELECTRICAL PARTS LIST

REF. NO.	PART NO.	DESCRIPTION			
<b>RESISTORS</b>					
R815×6	07-05033-06	3R3	1/6W	5%	Carbon Film Resistor
R813×2	07-05068-06	6R8	1/6W	5%	Carbon Film Resistor
R813×4	07-05075-06	7R5	1/6W	5%	Carbon Film Resistor
R814×4	07-05330-06	33	1/6W	5%	Carbon Film Resistor
R814×2	07-05470-06	47	1/6W	5%	Carbon Film Resistor
R809×4	07-05680-06	68	1/6W	5%	Carbon Film Resistor
R810×6	07-05471-06	470	1/6W	5%	Carbon Film Resistor
R721	07-05102-06	1K	1/6W	5%	Carbon Film Resistor
R722	07-05122-06	1K2	1/6W	5%	Carbon Film Resistor
R812×6	07-05103-06	10K	1/6W	5%	Carbon Film Resistor
R104, R106, R108, R110, R112, R114, R116, R204, R206, R208, R210, R212, R214, R216	07-05105-06	1M	1/6W	5%	Carbon Film Resistor
R1, R342, R343, R361, R442, R443, R461, R501, R502, R733	07-05101-04	100	1/4W	5%	Carbon Film Resistor
R309, R409	07-05241-04	240	1/4W	5%	Carbon Film Resistor
R355, R455	07-05331-04	330	1/4W	5%	Carbon Film Resistor
R330, R430, R526, R720, R737, R523, R305, R405, R508, R527, R528, R311, R411	07-05102-04	1K	1/4W	5%	Carbon Film Resistor
R727, R728, R729, R730, R731, R732	07-05222-04	2K2	1/4W	5%	Carbon Film Resistor
R323, R324, R423, R424, R718, R736	07-05332-04	3K3	1/4W	5%	Carbon Film Resistor
R325, R326, R357, R356, R425, R426, R456, R457, R504, R509, R510, R511, R512, R513, R514, R515, R516, R517, R518, R519, R520, R521, R522, R524, R725, R726	07-05472-04	4K7	1/4W	5%	Carbon Film Resistor
R335, R336, R435, R436	07-05822-04	8K2	1/4W	5%	Carbon Film Resistor
R505, R506, R507, R525, R701, R702, R709, R710, R717, R735	07-05103-04	10K	1/4W	5%	Carbon Film Resistor
R354, R454	07-05223-04	22K	1/4W	5%	Carbon Film Resistor
R503, R719	07-05104-04	100K	1/4W	5%	Carbon Film Resistor
R723, R724, R734	07-05154-04	150K	1/4W	5%	Carbon Film Resistor
 R353, R453	07-05750-02C	75	1/2W	5%	Fusible Resistor
R805×6, R806×6	07-05680-06D	68	1/6W	5%	Metal Film Resistor
R802×6	07-05101-06D	100	1/6W	5%	Metal Film Resistor
R301, R401	07-01152-06D	1k5	1/6W	1%	Metal Film Resistor
R803×6	07-05222-06D	2K2	1/6W	5%	Metal Film Resistor
R341, R441	07-05332-06D	3K3	1/6W	5%	Metal Film Resistor
R819×6, R807×6	07-05103-06D	10K	1/6W	5%	Metal Film Resistor
R801×6	07-01225-06D	2M2	1/6W	1%	Metal Film Resistor
R307, R407	07-01110-04D	11	1/4W	1%	Metal Film Resistor
R332, R432	07-05750-04D	75	1/4W	5%	Metal Film Resistor

# ELECTRICAL PARTS LIST CONTINUATION

REF. NO.	PART NO.	DESCRIPTION			
R713, R716	07-01111-04D	110	1/4W	1%	Metal Film Resistor
R705, R708	07-011150-04D	115	1/4W	1%	Metal Film Resistor
R304, R404, R348, R448	07-01121-04D	120	1/4W	1%	Metal Film Resistor
R310, R410	07-01201-04D	200	1/4W	1%	Metal Film Resistor
R318, R418	07-012130-04D	213	1/4W	1%	Metal Film Resistor
R315, R415	07-01221-04D	220	1/4W	1%	Metal Film Resistor
R101, R201	07-05221-04D	220	1/4W	5%	Metal Film Resistor
R103, R105, R107, R203, R109, R111, R113, R115, R117, R205, R207, R209, R211, R213, R215, R217	07-05471-04D	470	1/4W	5%	Metal Film Resistor
R327, R329, R427, R429, R346, R446, R351, R451, R328, R428	07-014990-04D	499	1/4W	1%	Metal Film Resistor
R320, R420	07-01591-04D	590	1/4W	1%	Metal Film Resistor
R338, R438	07-05821-04D	820	1/4W	5%	Metal Film Resistor
R319	07-05102-04D	1k	1/4W	5%	Metal Film Resistor
R303, R306, R308, R359, R403, R406, R408, R459, R347, R447	07-01102-04D	1k	1/4W	1%	Metal Film Resistor
R714, R715	07-01222-04D	2K2	1/4W	1%	Metal Film Resistor
R344, R444, R450, R350	07-012741-04D	2K74	1/4W	1%	Metal Film Resistor
R358, R458	07-01332-04D	3K3	1/4W	1%	Metal Film Resistor
R316, R416	07-05332-04D	3K3	1/4W	5%	Metal Film Resistor
R706, R707	07-01472-04D	4K7	1/4W	1%	Metal Film Resistor
R317	07-05103-04D	10K	1/4W	5%	Metal Film Resistor
R333, R433	07-01113-04D	11K	1/4W	1%	Metal Film Resistor
R345, R445	07-05123-04D	12K	1/4W	5%	Metal Film Resistor
R321, R421	07-05153-04D	15K	1/4W	5%	Metal Film Resistor
R352, R452	07-012112-04D	21.1K	1/4W	1%	Metal Film Resistor
R313, R413	07-05223-04D	22K	1/4W	5%	Metal Film Resistor
R349, R449	07-05363-04D	36K	1/4W	5%	Metal Film Resistor
R314, R414	07-01513-04D	51K	1/4W	1%	Metal Film Resistor
R337, R437	07-05513-04D	51K	1/4W	5%	Metal Film Resistor
R334, R434	07-011373-04D	137K	1/4W	1%	Metal Film Resistor
R711	07-05332-02D	3K3	1/2W	5%	Metal Film Resistor
R712	07-05682-02D	6K8	1/2W	5%	Metal Film Resistor
R703	07-05153-02D	15K	1/2W	5%	Metal Film Resistor
R704	07-05223-02D	22K	1/2W	5%	Metal Film Resistor
<b>POTENTIOMETERS</b>					
RV1, RV2	09-25103-14A	10KA	Treble and Bass Potentiometer		
RV3	09-25103-12M	10KA	Volume Potentiometer		
RV4	09-25120314A	20K MN	Balance Potentiometer		
RV5	10-01102-00T	1K	Pre-out Potentiometer		
R322, R422	10-01103-00T	10K	Semi-fixed Potentiometer		
<b>CAPACITORS</b>					
C318	05-01120-05	12pF	100V	±5%	Ceramic Disk Capacitors
C426, C326	05-01180-10	18pF	100V	±10%	Ceramic Disk Capacitors
C502, C503	05-01220-10	22pF	100V	±10%	Ceramic Disk Capacitors
C804×6	05-01250-10	25pF	100V	±10%	Ceramic Disk Capacitors
C324, C424	05-01390-10	39pF	100V	±10%	Ceramic Disk Capacitors

# ELECTRICAL PARTS LIST CONTINUATION

REF. NO.	PART NO.	DESCRIPTION			
C315	05-01430-02	43pF	100V	±5%	Ceramic Disk Capacitors
C802×6	05-01470-10	47pF	100V	±10%	Ceramic Disk Capacitors
C308, C408	05-01680-10	68pF	100V	±10%	Ceramic Disk Capacitors
C334, C434	05-01820-10	82pF	100V	±10%	Ceramic Disk Capacitors
C102, C103, C104, C105, C106, C107, C108, C208, C109, C202, C203, C204, C205, C206, C207, C209, C311, C312, C411, C412, C401, C301	05-01101-10	100pF	100V	±10%	Ceramic Disk Capacitors
C801×6	05-01221-10	220pF	100V	±10%	Ceramic Disk Capacitors
C313, C345, C346, C349, C413, C445, C446, C449	05-01221-10	220pF	100V	±10%	Ceramic Disk Capacitors
C341, C441	05-01471-10	470pF	100V	±10%	Ceramic Disk Capacitors
C304, C404	05-01821-10	820pF	100V	±10%	Ceramic Disk Capacitors
C351, C451	05-01222-20	2.2nF	100V	±20%	Ceramic Disk Capacitors
C1, C5, C6, C506, C507, C508, C509, C510, C511, C512, C754	05-01103-20	10nF	100V	+50%-20%	Ceramic Disk Capacitors
C302, C402	05-11104-20	0.1uF	100V	±20%	Ceramic Disk Capacitors
C333, C347, C348, C350, C433, C415, C501, C513, C806×6, C807×6	05-11104-20	0.1uF	100V	±20%	Ceramic Disk Capacitors
C316, C331, C416, C431, C712, C713, C714, C715, C724, C725, C726, C727, C733, C734, C740, C745, C746, C747, C748	05-11104-20	0.1uF	100V	±20%	Ceramic Disk Capacitors
⚠ CE2, CE3×C,B	05-02222-20	2.2nF	250V	±20%	Ceramic Disk Capacitors
⚠ C701	05-04472-20	4.7nF	400V	±20%	Ceramic Disk Capacitors
C335, C435	05-31682-10	6.8nF	100V	±10%	Polyster Film Capacitors
C338, C438	05-31223-10	22nF	100V	±10%	Polyster Film Capacitors
C706, C707, C718, C719, C730, C736	05-31104-10	0.1uF	100V	±10%	Polyster Film Capacitors
C330, C430	05-21222-05A	2.2nF	100V	±5%	Polyster Film Capacitors
C327, C427	05-21682-02A	6.8nF	100V	±2%	Polyster Film Capacitors
C336, C436	05-21183-02A	18nF	100V	±2%	Polyster Film Capacitors
C328, C428	05-21243-02A	24nF	100V	±2%	Polyster Film Capacitors
C337, C437	05-21104-02A	100nF	100V	±2%	Polyster Film Capacitors
C810×6, C343, C443	05-20224-05A	220nF	63V	±5%	Polyster Film Capacitors
C703, C704, C705	05-21224-05A	220nF	100V	±5%	Polyster Film Capacitors
C702	05-22224-05A	220nF	250V	±5%	Polyster Film Capacitors
C339, C439	05-20154-05A	0.15uF	63V	±5%	Metallized Polyster Film Capacitors
C340, C440	05-20105-05A	1uF	63V	±5%	Metallized Polyster Film Capacitors
C309, C409, C317, C417, C752, C753	06-25475-20	4.7uF	25V	±20%	Electrolytic Capacitors
C710, C711	06-101475-20	4.7uF	100V	±20%	Electrolytic Capacitors
C803×6, C805×6	06-16106-20M	10uF	16V	±20%	Electrolytic Capacitors
C504, C728, C729, C735, C738, C741, C743, C744, C749, C750, C757, C758	06-25106-20	10uF	25V	±20%	Electrolytic Capacitors
C732	06-35106-20	10uF	35V	±20%	Electrolytic Capacitors
C716, C717, C722, C723, C739, C742, C756, C759	06-50106-20	10uF	50V	±20%	Electrolytic Capacitors
C808×6	06-35226-20M	22uF	35V	±20%	Electrolytic Capacitors
C325, C425, C352, C452	06-25476-10	47uF	25V	±10%	Electrolytic Capacitors

# ELECTRICAL PARTS LIST CONTINUATION

REF. NO.	PART NO.	DESCRIPTION			
C319, C320, C321, C329, C419, C420, C421, C429, C751	06-25476-20	47uF	25V	±20%	Electrolytic Capacitors
C344, C444	06-16107-20	100uF	16V	±20%	Electrolytic Capacitors
C322, C323, C422, C423, C405, C305	06-25107-20	100uF	25V	±20%	Electrolytic Capacitors
C332, C432	06-25227-20	220uF	25V	±20%	Electrolytic Capacitors
C303, C403	06-16477-20	470uF	16V	±20%	Electrolytic Capacitors
C306, C307, C310, C406, C407, C410	06-25477-20	470uF	25V	±20%	Electrolytic Capacitors
C708, C709	06-101108-20	1000uF	100V	+50%-20%	Electrolytic Capacitors
C731	06-35228-20	2200uF	35V	±20%	Electrolytic Capacitors
C720, C721	06-50338-20	3300uF	50V	±20%	Electrolytic Capacitors
C737	06-25478-20	4700uF	25V	±20%	Electrolytic Capacitors
<b>TRANSISTORS</b>					
Q508, Q706, Q709, Q710, Q711, Q712, Q713, Q805×4	01-01015-070	2SA1015-GR			Small Signal Transistor
Q311, Q411	01-00872-020	2SA872AE			Small Signal Transistor
Q302, Q402, Q802×6, Q803×6, Q804×6, Q806×6	01-00970-000	2SA970			Small Signal Transistor
Q303, Q403, Q701, Q703, Q705	01-00647-000	2SB647A			Power Transistor
Q808×6	01-00649-001	2SB649A			Power Transistor
Q310, Q410	01-01775-000	2SC1775AE			Small Signal Transistor
Q501, Q502, Q503, Q504, Q505, Q506, Q507, Q509, Q707, Q708, Q714	01-01815-070	2SC1815-GR			Small Signal Transistor
Q313, Q413	01-02878-000	2SC2878-A			Switch Transistor
Q301, Q401	01-03329-000	2SC3329			Small Signal Transistor
Q304, Q404, Q702, Q704	01-00667-001	2SD667A			Power Transistor
Q807×6	01-00669-001	2SD669A			Power Transistor
Q801×6	01-00369-000	2SK369			Junction FET
<b>DIODES</b>					
D801×6, D802×6	02-24148-00	1N4148			SW Diode
D501, D502, D503, D504, D706, D711, D712, D716, D717, D718, D719, D720, D721, D722, D723	02-24148-00	1N4148			SW Diode
D505, D506, D701, D702, D703, D704, D705, D707, D708, D709, D710, D713, D724	02-24148-00	1N4148			SW Diode
D715	02-24148-00	1N4148			SW Diode
LD501, LD502, LD503, LD504, LD505, LD506	02-35134-155	5134D		φ5	Green LED
LD507	02-30513-155				Amber LED
LD508	02-30515-255	LED2		φ5	Dual-colour LED
D714	02-00180-05	18V			Zener Diode
B701, B702, B703, B704	02-44004-00	KBL10			Rectifier Bridge
<b>ICS</b>					
IC1	03-05532-03	NE5532A			DUAL OP-AMP
IC501	03-00074-14	74LS00			QUAD NAND

# ELECTRICAL PARTS LIST CONTINUATION

REF. NO.	PART NO.	DESCRIPTION	
IC502	03-00812-18	Z86E0812PSC	NAD Micon(Programmed)
IC503	03-10621-03	IS1U621L	IR Sensor
IC701, IC703	03-00317-03	LM317	Regulator
IC702, IC704	03-00337-03	LM337	Regulator
IC706	03-07805-03	LM7805	Regulator
IC705	03-07812-03	LM7812M	Regulator
IC707	03-07818-03	LM7818	Regulator
IC708	03-07918-03	LM7918	Regulator
IC504, IC505	03-04094-16	4094	Standard CMOS
<b>CRYSTAL</b>			
X501	04-12000-00	12MHz	Crystal
<b>INDUCTORS</b>			
⚠ T1*B,C	08-67265-00	TI-67265B	Transformer
⚠ T1*AH	08-67266-00	TI-67266B	Transformer
L301, L401	22-01000-06	100uH	±20% Toroidal Inductor
L302, L402	22-03701-06	3.7mH	±10% Toroidal Inductor
⚠ FT1*B,C	22-10183-00	2x1.8mH	Filter
<b>SWITCHES</b>			
SW1	11-02022-02A	MM/MC	Slide Switch
SW2	11-01022-01	DPDT	Push Switch
⚠ SW701	11-01001-00		Power Switch
K501, K502, K503, K504, K505, K506, K507	11-00004-01		Tact Switch
<b>RELAY</b>			
RL1, RL2, RL3, RL4, RL5, RL6, RL7, RL8, RL9	12-02005-01	5V	Relay
<b>FUSES</b>			
⚠ F702, F703, F704, F705, F706, F707	20-00050-25	T500mA 250V	Time-lag Fuse
	20-01000-00		Fuse Holder
<b>OTHERS</b>			
P17, P18, P19	13-01000-00		Test Pin
⚠ AC1, AC2*AH	17-3000-02A		AC Outlets
RCA1, RCA2, RCA3, RCA4, RCA5, RCA6	17-01200-04		4-pin RCA Socket
RCA7	17-01200-02	NADLINK IN	2-pin RCA Socket
PJ1	17-00200-01	PHONEJACK	Headphone Jack
PJ2	17-03000-01D	+12V OUT	Power Socket

# EXPLODED VIEW PARTS LIST

REF. NO.	PART NO.	DESCRIPTION	Qty.	REF. NO.	PART NO.	DESCRIPTION	Qty.
C001	45-00160-01	Chassis	1	F009	53-00160-03	Fixing Bracket	2
C002	45-00300-04	Base Cover	1	F010	45-00300-10	IR Cover	1
C003	53-00320-05	Foot	4	F011	52-00160-01	Input Button (3P)	2
C004	56-00320-01	Foot Pad	4	F012	52-00160-02	Input Button (1P)	1
C005	09-25103-12M	Volume Potentiometer	1	F013	54-00160-01	LED LENS	8
C006	09-25203-14A	Balance POT	1	S001	45-00160-02	Subfascia	1
C007	11-01022-01	Push Switch	1	S002	53-00160-02	Sleeve (1P)	1
C008	09-25103-14A	Treble and Bass POTs	2	S003	53-00160-01	Sleeve (7P)	1
C009	40-08045-22	Bolt	1	S004	45-00160-04	IR Cover	1
C010	45-00320-07	Trans. Bracket	1	S005	45-00160-03	Bracket (PH.)	1
C011	43-08002-00	Spring Washer	2	S006	11-01001-00	Power Switch	1
C012	41-08008-00	Nut	2	S007	17-00200-01	Headphone Jack	1
C013	46-00160-03	Shielding Box	1	R001*C	46-00160-02	Rear Panel	1
C014	56-00320-05	Rubber Pad	1	R001*AH	46-00160-02H	Rear Panel	1
⚠ C015*C	08-67265-00	Transformer	1	⚠ R002*C	15-00183-00C	AC Cord	1
⚠ C015*AH	08-67266-00	Transformer	1	R002*AH	15-00203-00H	AC Cord	1
C016	56-00160-05	Rubber Pad	1	⚠ R003	58-00320-01	Strain Relief Bushing	1
C017	45-00320-09	Transformer Disc	1	⚠ R004*AH	17-3000-02A	AC Outlets	2
C018	69-00160-02	Transformer Label	1	R005	51-00160-01	Pre-out Knob	1
C019	48-00300-02	BUS BAR (2)	1	R006	45-00160-06	Ground Post Cap	1
C020	45-00300-05	PCB Support	2	R007	45-00160-07	Ground Post Bolt	1
C021	47-00300-04	Module Support 2	6	R008	32-03006-00	Eyelet	1
C022	55-00300-02	Module Lid	6	R009	40-04005-00	Nut	1
C023	47-00300-01	IC Heatsink	8	R010*C	40-04012-20	Machine Screw	5
C024	17-03000-01D	+12V Trigger Out Socket	1	R010*AH	40-04012-20	Machine Screw	3
C025	17-01200-02	2-Pin RCA Socket	1	R011*C	58-00160-01	Support	2
C026	17-01200-04	4-Pin RCA Socket	6	T001	46-00300-01	T-Cover	1
C027	48-00300-04	BUS BAR (3)	1	0001	40-04008-07	Self Taping Screw(4x8)	8
C028	45-00300-13	Trans.Clamp (Module)	6	0002	40-02008-01	Self Taping Screw(2x8)	6
C029	10-01103-00T	Preout Volume POT	1	0003	40-03008-01	Self Taping Screw(3x8)	4
F001	46-00160-01	Fascia (Alu)	1	0004	40-12606-01	Self Taping Screw(2.6x6)	7
F002	53-00320-02	Input Button Lozenge	1	0005	40-03006-01	Self Taping Screw(3x6)	52
F003	53-00320-01	Tone Control Lozenge	1	0006	40-13008-01	Self Taping Screw(3x8)	19
F004	51-00320-01	Volume Knob	1	0007	40-02604-22	Self Taping Screw(2.6x4)	2
F005	51-00320-02	Tone Knob	3				
F006	53-00300-02	Tone Button	1				
F007	52-00320-02	Power Button	1				
F008	53-00320-04	Power Button Bezel	1				



# EXPLODED VIEW

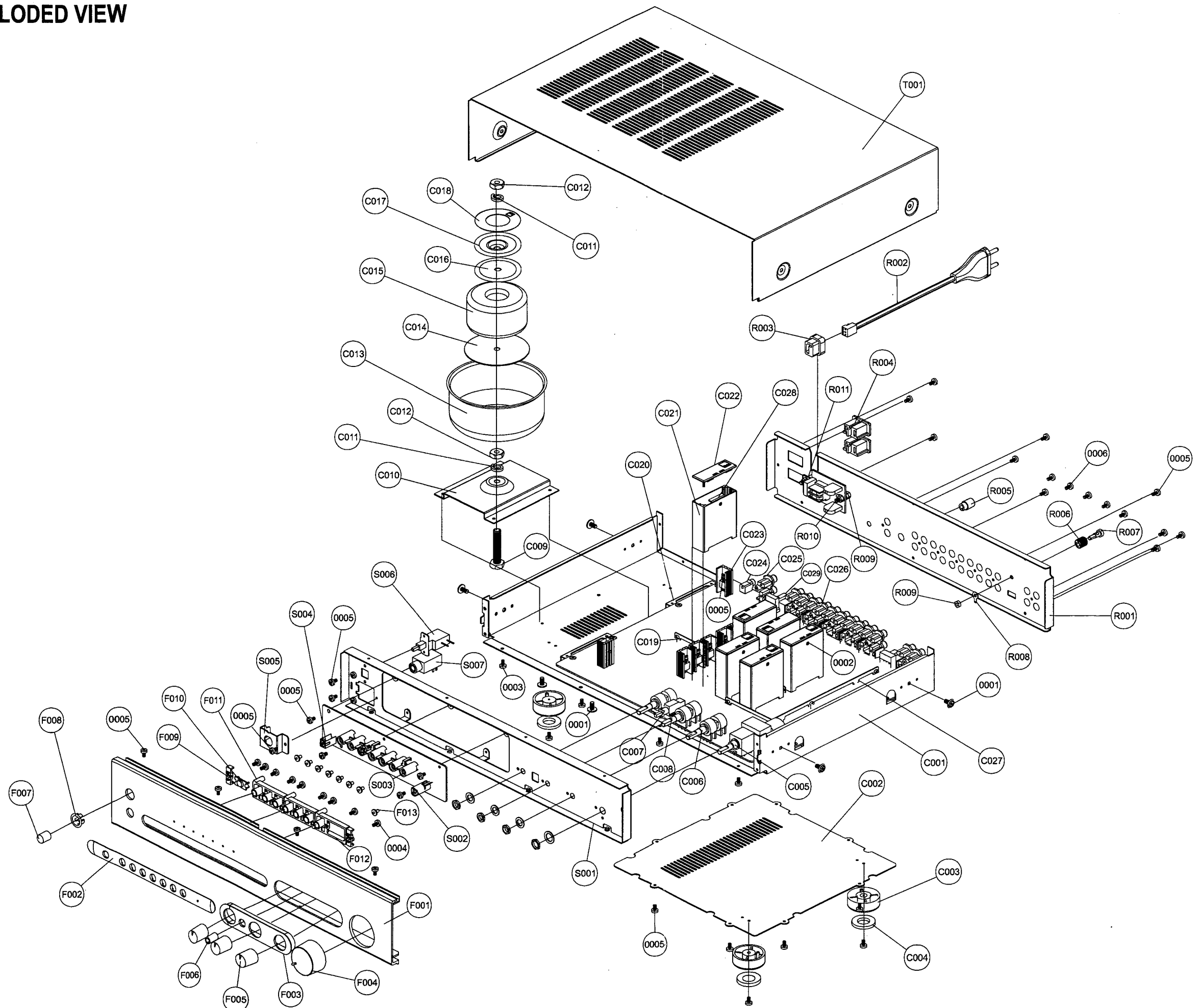

# PACKING DIAGRAM

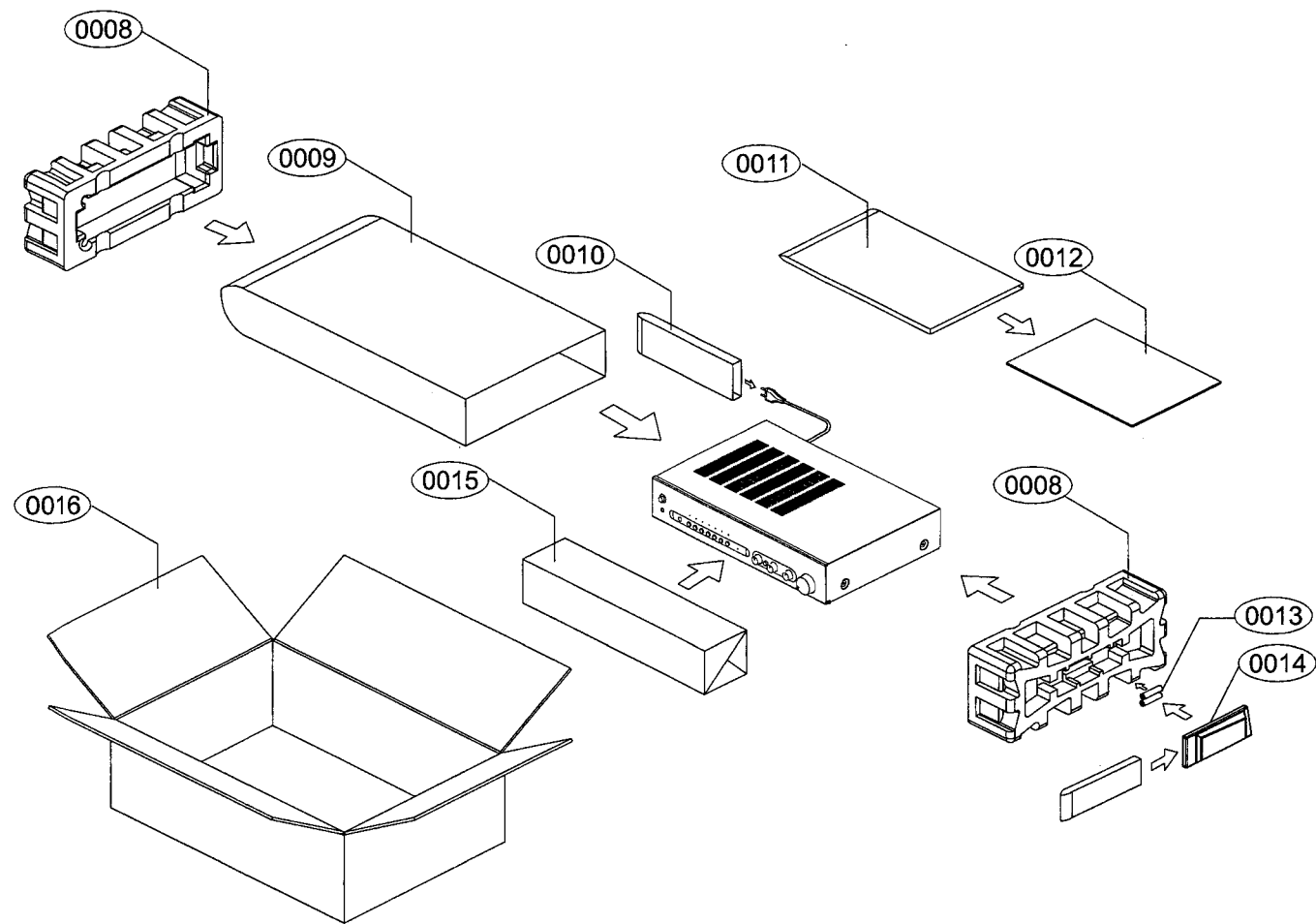

Ref. No.	Part No.	Description	Q'TY
0008.	62-00300-01	Polyfoam End Cap	2
0009.	63-00160-01	Polybag	1
0010.	63-00320-03	AC Cord Polybag	1
0011.	63-00320-02	Manual Polybag	1
0012.	65-00160-01	Instruction Manual	1
0013.	31-07150-00	Batteries	2
0014.	30-0C450-04	Remote Control	1
0015.	64-00300-01	EPE Fascia Cover	1
0016.	61-00160-01	Carton Box	1

Proprietary information for servicing purposes only.  
 The information herein may not be used commercially without the prior written agreement of NAD International, Toronto, Canada.